

3"

Architectural LED Downlight

EPD-3-RGBW

Edison Series

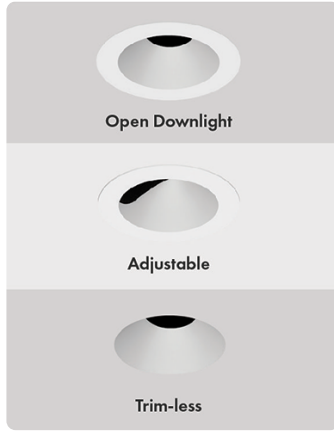

Application

A complete family of downlights, accent lights, wallwashers, double wallwashers, and corner wallwashers in multiple beam spreads and apertures designed for commercial, civic, museums, corporate, hospitality, academic, retail, medical, and houses of worship.

Features

- Exceptional Optical Quality: Up to 98 CRI, 1x2 Step MacAdam Ellipse.
- Shipped standard with a Solite Beam Smoother lens that removes striations from the light source.
- Available with a multitude of dimming protocols and control offerings.

Nominal Lumens	Delivered Lumens	Wattage
900L	861	12
1100L	998	14
1200L	1101	16

Based on 4000K, 90+ CRI with semi-specular chrome reflector. Actual wattage may vary +/-5%



Lumens	Tunable White: 700, 900, 1200, 1500, 2000 RGB + White: 1100
CCT & Dynamic Platforms	Tunable White: 50K-27K, 65K-27K RGB + White: LENGN-65K-18K
CRI	90+
Color Quality	2 Step MacAdam Ellipse
Distributions	SPD (Spot 15°), ND (Narrow 24°), MD (Medium 35°), MWD (Medium Wide 45°), WD (Wide 52°)
Trim Options	Downlight, Lensed Downlight, Adjustable, Lensed Wall Wash, Slot, Pinhole, Self Flanged, Trm-less, Square
Reflector Colors	CL (Semi-Specular Chrome), SHZ (Low Iridescent Satin Haze), W (White), BK (Black)
Flange Colors	WH (Self-Flanged White)
Dimming	Tunable White: DIM10, DMX-512, DMX-RDM, DALI, BLE, LUTH RGB + White: ELDODMX.1
Emergency	Tunable White: EMG-LED-10W[(Bodine BSL310)], EMG-LED-20W[(Bodine BSL20)] RGB + White: PELI-S-20, PELI-S-100, PELI-S-250, PELI-S-400
Lifetime	L70 at 50,000 Hours
Photometric Tests	In Accordance with IES LM79-08, LM80 and TM-30, TM-21
CCEA Option	For CCEA approved EPD-3 Series, please contact Edison Price Lighting for further information.



3"

Architectural LED Downlight

EPD-3-RGBW

Edison Series

PART NUMBER: **EPD-3-TWH-50K-27K-700L-90-SPD-DIM10-120V**

Series	Technology	Lumens	CRI	Optics	Driver	Voltage	Emergency	Options	Accessories
EPD-3-TWH <small>(Tunable White)</small>	50K-27K 65K-27K	700L 900L 1200L 1500L 2000L	90+	SPD <small>Spot (15°)</small> ND <small>Narrow (24°)</small> MD <small>Medium (35°)</small> MWD <small>Medium Wide (45°)</small> WD <small>Wide (52°)</small>	DIM10 DMX-512 DMX-RDM DALI BLE LUTH	120V 277V MVOLT	- EMG-LED-10V <small>(Bodine BSL310)</small> EMG-LED-20V <small>(Bodine BSL20)</small>	- CP USA	- EC-WC-TWH-HW-MVOLT <small>Dual-channel touch screen wall controller with tunable white technology, supporting 0-10V dimming.</small>

1 For DIM10 driver you must dedicate two control inputs, one for the Dimming Control and another for CCT Tuning
2 Lutron is the T-Series 2-Channel Tunable White EcoSystem

PART NUMBER: **EPD-3-RGBW-LENGN-65K-18K-1100L-90-SPD-ELDODMX.1-120V**

Series	Technology	Lumens	CRI	Optics	Driver	Voltage	Emergency	Options
EPD-3-RGBW <small>(RGB + White)</small>	LENGN-65K-18K	1100L	90+	SPD <small>Spot (15°)</small> ND <small>Narrow (24°)</small> MD <small>Medium (35°)</small> MWD <small>Medium Wide (45°)</small> WD <small>Wide (52°)</small>	ELDODMX.1	120V 277V MVOLT	- PELI-S-20 PELI-S-100 PELI-S-250 PELI-S-400	- CP USA

Note: All extra optical accessories, aperture assemblies, and optics can be ordered separately. Check EPL Website for ordering nomenclature.











































3"

Architectural LED Downlight

EPD-3-RGBW

Edison Series

ORDERING GUIDE:

REFLECTOR TYPE				MOUNTING	FINISH	
 EPD-3-132 Open Downlight	 EPD-3-138 Lensed Downlight <small>WET LOCATION</small>	 EPD-3-133 Adjustable	 EPD-3-137 Lensed Wall Wash <small>WET LOCATION</small>	 Round Flanged	 WH-WH White	 BK-WH Black
 EPD-3-130 Slot	 EPD-3-134 Pinhole Downlight				 CL-WH Clear Semi-Spec	 SHZ-WH Satin Haze
 EPD-3-TL-132 Open Downlight	 EPD-3-TL-138 Lensed Downlight <small>WET LOCATION</small>	 EPD-3-TL-133 Adjustable	 EPD-3-TL-137 Lensed Wall Wash <small>WET LOCATION</small>	 Round Trimless	 WH White	 BK Black
 EPD-3-TL-130 Slot	 EPD-3-TL-134 Pinhole Downlight				 CL Clear Semi-Spec	 SHZ Satin Haze
 EPD-3SQ-132 Open Downlight	 EPD-3SQ-138 Lensed Downlight <small>WET LOCATION</small>	 EPD-3SQ-133 Adjustable	 EPD-3SQ-137 Lensed Wall Wash <small>WET LOCATION</small>	 Square Flange	 WH-WH White	 BK-WH Black
 EPD-3SQ-134 Pinhole Downlight					 CL-WH Clear Semi-Spec	 SHZ-WH Satin Haze
 EPD-3SQ-TL-132 Open Downlight	 EPD-3SQ-TL-138 Lensed Downlight <small>WET LOCATION</small>	 EPD-3SQ-TL-133 Adjustable	 EPD-3SQ-TL-137 Lensed Wall Wash <small>WET LOCATION</small>	 Square Trimless	 WH White	 BK Black
 EPD-3SQ-TL-134 Pinhole Downlight					 CL Clear Semi-Spec	 SHZ Satin Haze

Note: The driver and emergency access are only available from the top of the luminaire in trim-less applications. Pinhole and slot options feature a black reflector and white trim only.

COLOR FILTERS:



- EPD-3-LENS-BL
- EPD-3-LENS-GR
- EPD-3-LENS-PI
- EPD-3-LENS-PU
- EPD-3-LENS-DL
- EPD-3-LENS-YE
- EPD-3-LENS-AM
- EPD-3-LENS-OR
- EPD-3-LENS-RE

DISTRUBUTION FILTERS:



- EPD-3-LENS-FR
- EPD-3-LENS-SF
- EPD-3-LENS-CL
- EPD-3-LENS-UV
- EPD-3-LENS-SP
- EPD-3-LENS-HC
- EPD-3-LENS-LI
- EPD-3-LENS-SOL

NOTE: Additional lens filters must only be used on open non-lensed downlight trim options

3"

Architectural LED Downlight

EPD-3-RGBW

Edison Series

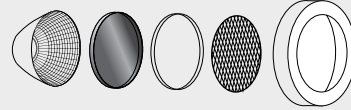
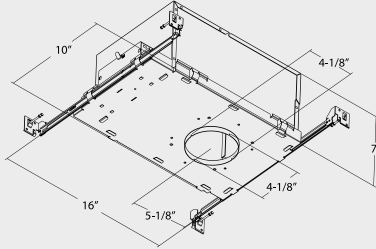

OPTICS

SPD (15°), ND (24°), MD (35°),
MWD (45°), WD (52°)

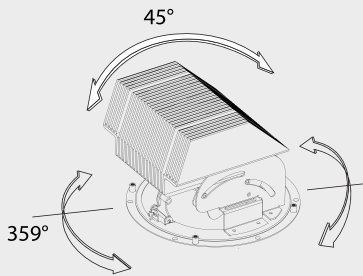

AIMING

Our proprietary hot aiming system, which allows for the precise positioning of the lamp to achieve the optimal beam alignment before trim installation.

Our specially designed lamp holder ensures that the central beam of the light source emerges correctly from the luminaire, accommodating angles from 0° to 45°.

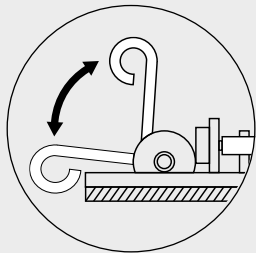

365° HORIZ. LOCKING

Seamlessly pivots along a 365-degree horizontal rotation within a sleek slotted groove track system.

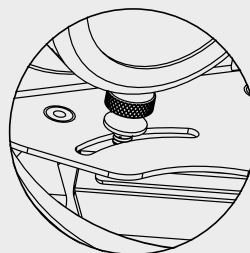

ADJUSTABILITY

Easy adjustment, without the requirement for tools, allows the luminaire to be positioned at angles of up to 45 degrees, ensuring optimal beam direction and maximum lumen output.

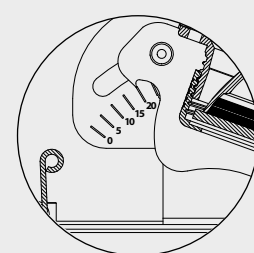

DEGREES

Enables simple on-site adjustments of the luminaires to achieve precision, performance, and versatility. During installation, you can securely set the beam angle in 1-degree increments, with clear markings at every 5-degree interval.



WWW.EPL.COM | 718.685.0700 | NEW YORK / LOS ANGELES

Last Update: Aug 20, 2024 - 14:55:49 ©Ali

3"

Architectural LED Downlight

EPD-3-RGBW

Edison Series

Modifications Available

Consult factory for modification requests; orders may require shop drawing approval.

Housing / Mounting

16-gauge steel, preassembled one-piece construction with integral 27" C-channel mounting brackets included. Mounting brackets may be adjusted up to 28" horizontally, and 2-3/4" vertically, and locking into place.

Emergency Options/Controls

The test switch for the emergency battery can be installed on the side of the reflector (integral INTG-EMG option), or the test switch can be mounted remotely (EMG-LED option). Self Diagnostic emergency option available (EMG-SDT-LED-10W) Typical lumen output of the luminaire is up to 1000L with EMG-LED-10W or INTG-EMG-LED-10W option & 2000L with EMG-LED-20W or INTG-EMG-LED-20W option in emergency mode. Other accessories and controls systems include modular wiring systems, daylight harvesting controls, occupancy sensors, and/or power packs for individual or room control applications.

Drivers

120/277V 50/60Hz; 347V available. THD < 20%; power factor >.09. Thermally protected. Removal of the reflector provides complete accessibility to the junction box, driver and internal components from above and below the ceiling through the aperture.

Listings

- c-UL-us - Listed for Feed Through Wiring.
- cULus Certified to UL 1598 / C22.2 suitable for Damp/Dry locations, indoor use only
- City of Chicago environmental air (CCEA) marking for plenum applications
- EMI/RFI emissions per FCC 47CFR Part 15 Class B
- RoHS - Contains no mercury or lead and RoHS compliant
- Photometric testing completed in accordance with IES LM-79, LM80 and TM-30 standards
- State of California Title 24 high efficacy LED compliance under JA8
- ENERGY STAR® certified with select trims and housings

Tunable White Option

Tunable White allows the luminaires to be color tuned via various controls. Create the perfect environment for the desired use of the space or mimic the natural color patterns throughout the day and stimulate circadian rhythm. Available in tuning range of 50K-27K (TWH-50K-27K), 65K-27K (TWH-65K-27K), 65K-18K (TWH-LENGN-65K-18K).

RGB + White Option

Refine your space with Mood Master (RGBW & TW), which provides complete control over hue, color temperature, saturation, and dimming for design versatility. RGB + White technology has a white color tuning range from 6500K to 1650K. RGB color range derived from the primary colors red, green and blue is used to create infinite color options in the RGB palette, adding colors together in varying amounts to create new ones. RGB Tunable White technology enables users to adjust the color temperature, adding gradients of saturated colors. No longer restricted to white light LEDs, lighting designers and architects can manipulate a space with desired hues and shades, altering the color temperature of the room, creating the perfect environment. The use of RGB Tunable White technology in allows infinite possibilities for any application

Dimming & Driver Information

DIM10 - 0-10V dimming on either MVOLT 120, 277 or 347V. Dimmable down to 1% of initial lumens, standard

DMX-512 - EldoLED PowerDrive dimming down to 0.1%. Please see EldoLED website for wiring diagrams and a list of compatible DMX and DALI control systems.

DMX-RDM - EldoLED PowerDrive dimming down to 0.1%. Please see EldoLED website for wiring diagrams and a list of compatible DMX and DALI control systems.

DALI - EldoLED SoloDrive DALI-2. Dimming down to 0.1%

BLE - Bluetooth Casambi enabled controllable

LUTH - Lutron LDE1 Hi-Lume Eco System with Soft Fade to Black 1% dimming

ELDODMX.1 - EldoLED PowerDrive dimming down to 0.1%. Please see EldoLED website for wiring diagrams and a list of compatible DMX and DALI control systems.



3"

Architectural LED Downlight

EPD-3-RGBW

Edison Series

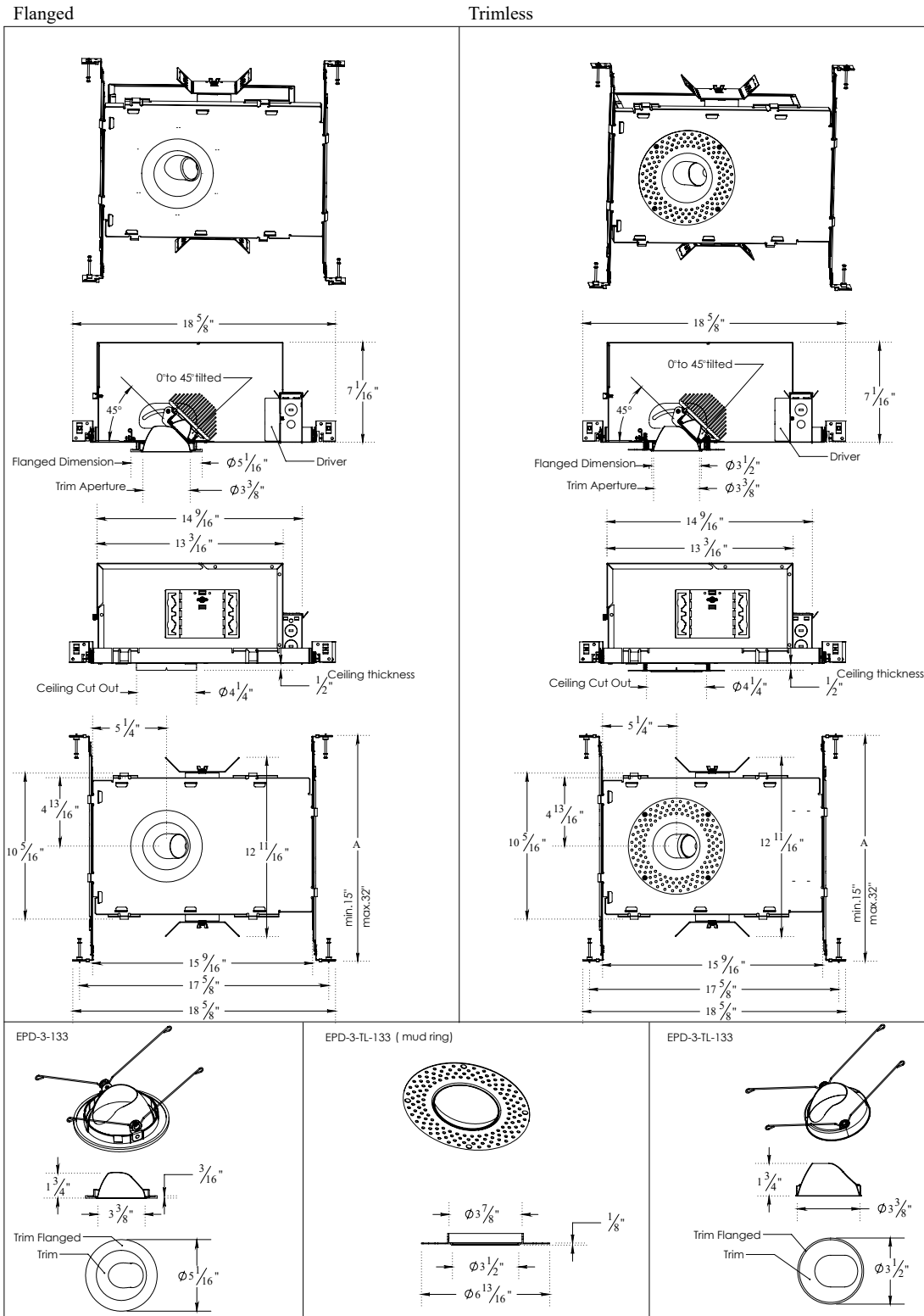

3"

Architectural LED Downlight

EPD-3-RGBW

Edison Series

EPD-3-2000 L-40K-90-MD-DIM 10-MVO LT-EPD-3SQ- 132

TEST NO: EPL121862

INPUT WATTS: 26 LUMENS: 936 CRI: 90 EFFICACY: 4 CCT: #000K SPACING CRITERIA: 0.68

Candle Power Distribution Curve

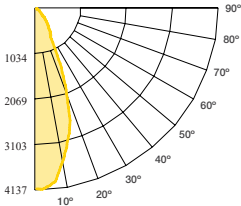

Table with 3 columns: Distance to Plane, Footcandle at Nadir, Beam diameter. Rows for 4.0, 8.0, 12.0, 16.0, 20.0, 24.0.

Zonal Lumens Summary

Table with 4 columns: Zone, Lumens, %Lamp, %Fixt. Rows for 0-20, 0-30, 0-40, 0-60, 0-80, 0-90.

Luminance (Average candela/M)

Table with 4 columns: Angle in Degrees, Average 0°, Average 45°, Average 90°. Rows for 45, 55, 65, 75, 85.

Lumens Per Zone

Table with 2 columns: Zone, Lumens. Rows for 0-10, 10-20, 20-30, 30-40, 40-50, 50-60, 60-70, 70-80, 80-90.

Candela Tabulation

Table with 2 columns: Candela, Lumens. Rows for 0, 5, 15, 25, 35, 45, 55, 65, 75, 85, 90.

Coefficients of Utilization- Zonal Cavity Method Effective Floor Cavity Reflectance 0.20

Large table with 13 columns: RC, RW, and various reflectance percentages (70%, 50%, 30%, 10%, 0%). Rows for 0-10, 10-20, 20-30, 30-40, 40-50, 50-60, 60-70, 70-80, 80-90.

EPD-3-2000 L-40K-90-ND-DIM 10-MVO LT-EPD-3SQ- 132

TEST NO: EPL121859

INPUT WATTS: 26 LUMENS: 974 CRI: 90 EFFICACY: 40 CCT: #000K SPACING CRITERIA: 0.58

Candle Power Distribution Curve

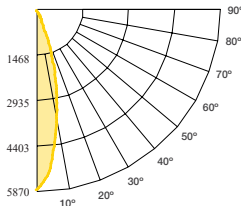

Table with 3 columns: Distance to Plane, Footcandle at Nadir, Beam diameter. Rows for 4.0, 8.0, 12.0, 16.0, 20.0, 24.0.

Zonal Lumens Summary

Table with 4 columns: Zone, Lumens, %Lamp, %Fixt. Rows for 0-20, 0-30, 0-40, 0-60, 0-80, 0-90.

Luminance (Average candela/M)

Table with 4 columns: Angle in Degrees, Average 0°, Average 45°, Average 90°. Rows for 45, 55, 65, 75, 85.

Lumens Per Zone

Table with 2 columns: Zone, Lumens. Rows for 0-10, 10-20, 20-30, 30-40, 40-50, 50-60, 60-70, 70-80, 80-90.

Candela Tabulation

Table with 2 columns: Candela, Lumens. Rows for 0, 5, 15, 25, 35, 45, 55, 65, 75, 85, 90.

Coefficients of Utilization- Zonal Cavity Method Effective Floor Cavity Reflectance 0.20

Large table with 13 columns: RC, RW, and various reflectance percentages (70%, 50%, 30%, 10%, 0%). Rows for 0-10, 10-20, 20-30, 30-40, 40-50, 50-60, 60-70, 70-80, 80-90.

EPD-3-2000 L-40K-90-WD-DIM 10-MVO LT-EPD-3SQ- 132

TEST NO: EPL121867

INPUT WATTS: 27 LUMENS: 992 CRI: 90 EFFICACY: 36 CCT: #000K SPACING CRITERIA: 0.80

Candle Power Distribution Curve

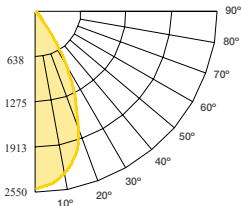

Table with 3 columns: Distance to Plane, Footcandle at Nadir, Beam diameter. Rows for 4.0, 8.0, 12.0, 16.0, 20.0, 24.0.

Zonal Lumens Summary

Table with 4 columns: Zone, Lumens, %Lamp, %Fixt. Rows for 0-20, 0-30, 0-40, 0-60, 0-80, 0-90.

Luminance (Average candela/M)

Table with 4 columns: Angle in Degrees, Average 0°, Average 45°, Average 90°. Rows for 45, 55, 65, 75, 85.

Lumens Per Zone

Table with 2 columns: Zone, Lumens. Rows for 0-10, 10-20, 20-30, 30-40, 40-50, 50-60, 60-70, 70-80, 80-90.

Candela Tabulation

Table with 2 columns: Candela, Lumens. Rows for 0, 5, 15, 25, 35, 45, 55, 65, 75, 85, 90.

Coefficients of Utilization- Zonal Cavity Method Effective Floor Cavity Reflectance 0.20

Large table with 13 columns: RC, RW, and various reflectance percentages (70%, 50%, 30%, 10%, 0%). Rows for 0-10, 10-20, 20-30, 30-40, 40-50, 50-60, 60-70, 70-80, 80-90.

